

Duravac 4400 USG 205" CA

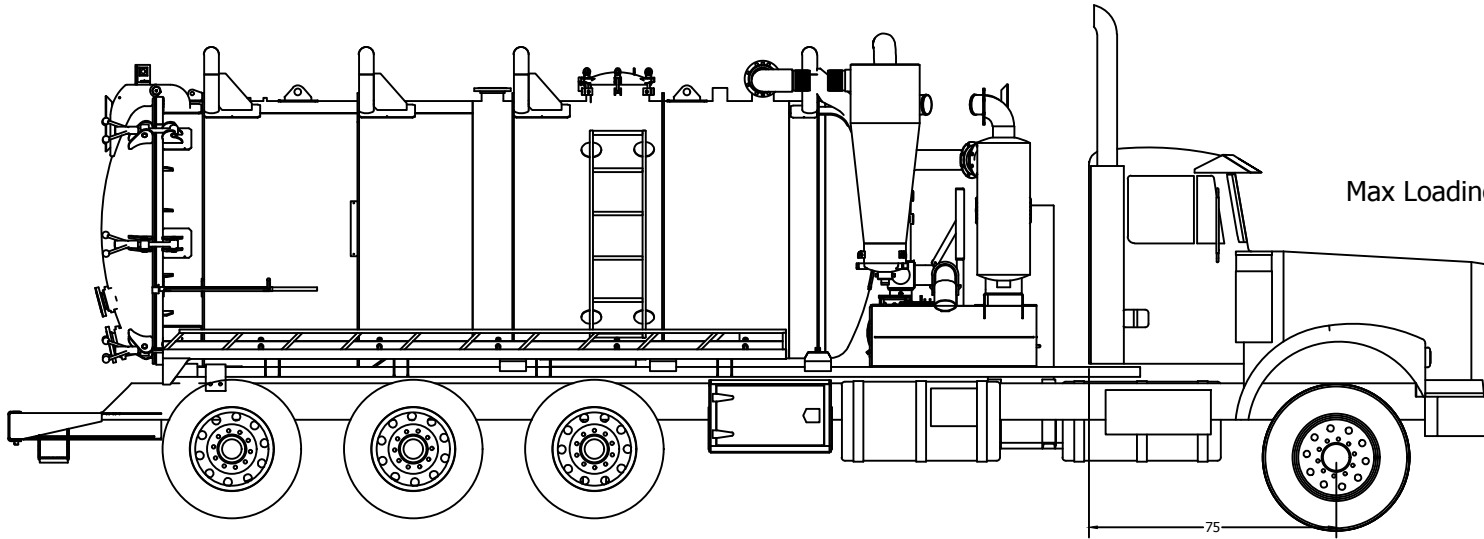

	FRONT	REAR (LB)
Axle Loading:	17890	42500
Max Loading (Bridge Law):	20000	42500
payload (Bridge Law):	18200	
GVW (Bridge Law):	60500	
Overturn Limit:	80000	
GVWR:	80000	

